

A detailed overview of EKATO's scope of services and contacts for your local area can be found at our website www.ekato.com

EKATO
Rühr- und Misch-
technik GmbH

Hohe-Flum-Str. 37
79650 Schopfheim
Germany

Tel. +49 (0) 7622 29-0
Fax +49 (0) 7622 29-213
E-mail: info@ekato.com

Mixing Technologies

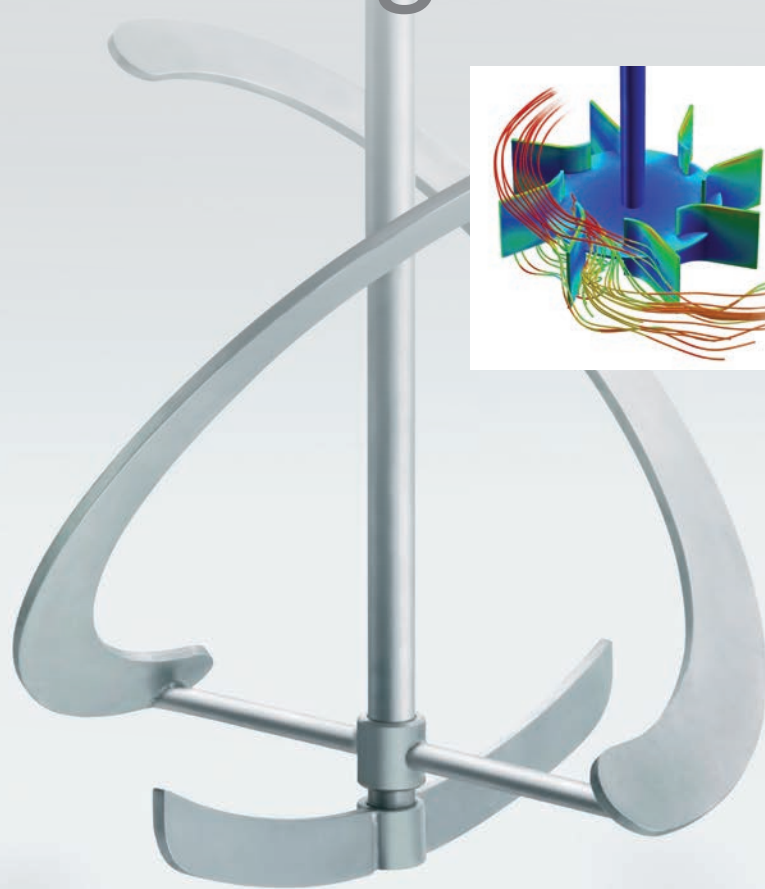
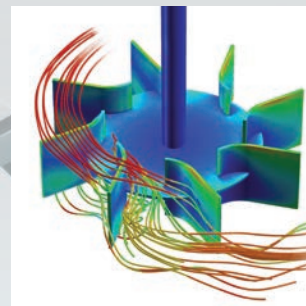
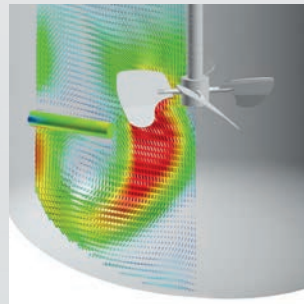

EKATO

Process Plants
Reactor Engineering
Mixing Systems
Mechanical Seals
Worldwide Service



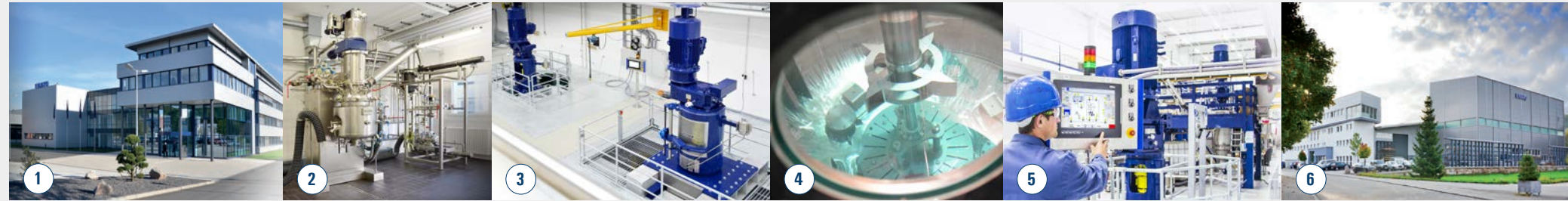

EKATO Rühr- und Mischtechnik GmbH

offers a broad range of services for the process-oriented industry from a single source: process analysis, engineering, scale-up, manufacturing, assembly and a worldwide sales and service network. With tailor-made solutions for mixing processes, EKATO is a competent development and engineering partner. Only optimally adjusted process and plant parameters guarantee a trouble-free plant operation with high throughputs and optimum product quality. Ranging from an analysis of process-side requirements, followed by tests with physical models, flow simulations (CFD) and finite element analysis (FEA) – EKATO achieves optimum results using the latest engineering tools available.

Whether an agitator, reactor model or complete process plant is required, the EKATO standard has been at the highest level for decades. State-of-the-art technologies and highly qualified employees in Germany guarantee a high quality and long service life that is “made in Germany”.

Optimized mixing technology for all process-oriented branches - from the mechanical seal to the complete process plant - Complete solutions from one source

- Founded in 1933
- 425 highly-qualified employees
- More than 250,000 delivered agitators
- 60 offices and representatives worldwide

Process plants:

- Hydrogenation
- Polymerization
- Crystallization

Reactor engineering:

- Analysis of the process-side requirements using tests in laboratory scale
- State-of-the-art simulation and calculation methods (CFD / FEA)
- Scale-up to production scale

Product range

- EKATO HWL, HWL-U, ESM, KOAX - customer-specific designed reactors and agitators for a variety of installation positions
- EKATO large agitators for special bulk applications
- EKATO impellers – the perfect basis for optimized processes
- EKATO ESD – mechanical seals and supply systems

Service:

- 24 hour service worldwide

Building

- 1 Headquarters with research center
- 2 Laboratory with 50 l test facility
- 3 Research center
- 4 Test arrangement
- 5 Plant with control unit
- 6 Large assembly hall

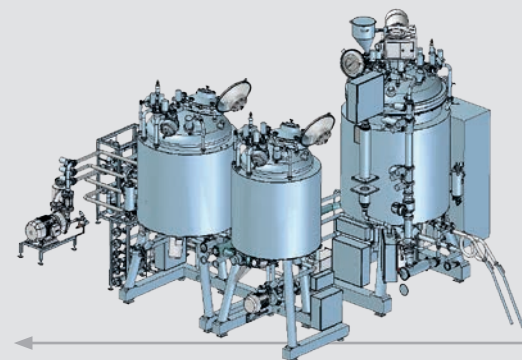

Process Plants



Supply systems

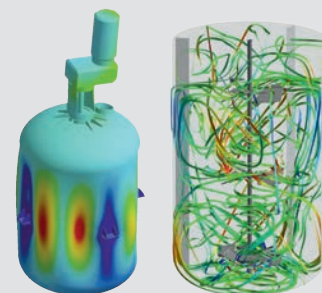

Reactor Engineering

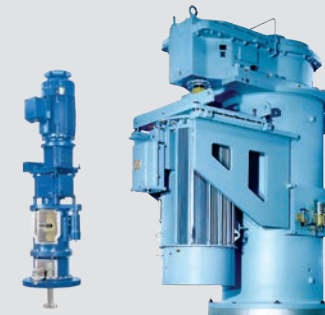
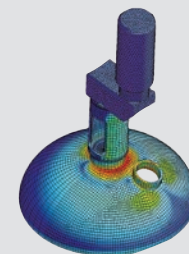

Agitators



Impellers



Mechanical Seals